

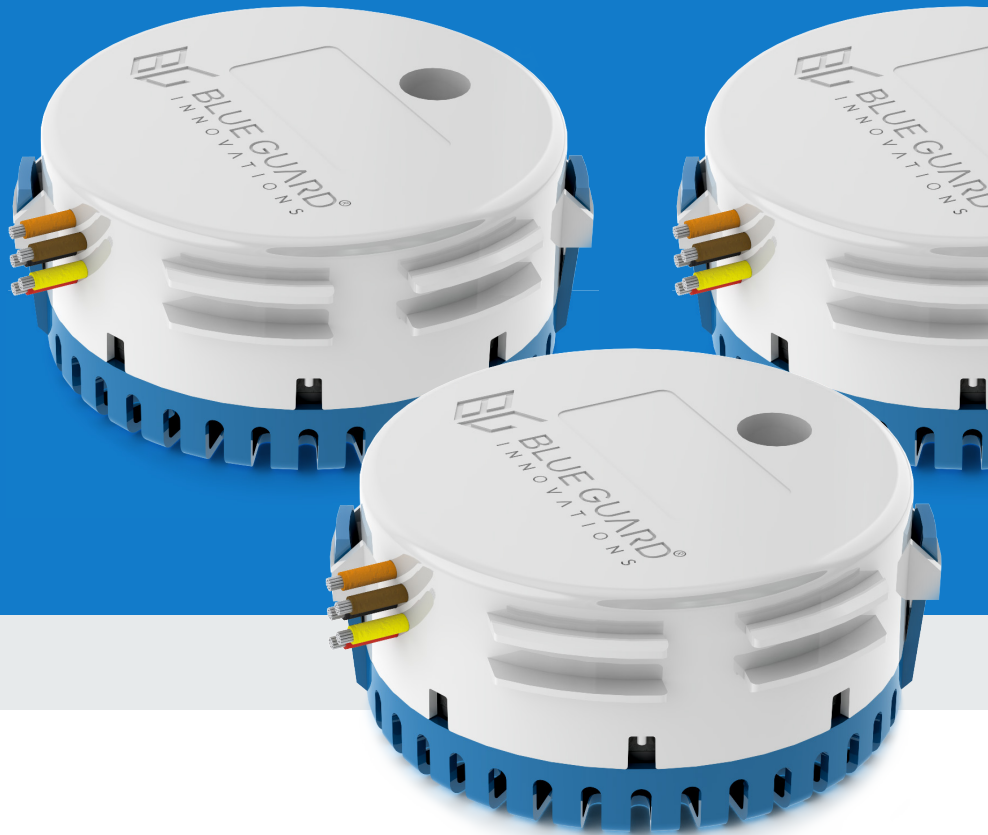

# BG-One

Oil and Fuel Detector with  
Smart Bilge Pump Switch

SPEC SHEET



## OVERVIEW

### About

The BG-One (Oil and Fuel Detector with Smart Bilge Pump Switch) integrates with the bilge pump system to selectively pump out water and not oil or fuel, preventing the vessel from accumulating water and aiding in the prevention of costly oil or fuel spills. The BG-One was developed in collaboration with the marine industry needing a reliable, long lasting bilge pump switch. Having no moving parts or float switches that can easily be damaged, the BG-One will automatically turn off the bilge pump when oil or fuel is detected before a costly spill occurs. The BG-One will connect to any 12 or 24 Vdc bilge pump and alarm panel on the market today. The BG-One is CE and ISO 8846 Marine Ignition Protection Certified, tested to ABYC-1500 standards. Patented technology.

### Reliability

With IP-68 rated durability, the BG-One is made with rugged, non-corrosive ABS plastic. The sensor comes with a heavy-duty mounting bracket to attach to a bulkhead or frame with #8x0.75" 316 stainless steel screws. Heavy-duty 14 gauge marine grade wires connect the BG-One to the bilge pump and the BG-JBox (Junction Box) that should be mounted high on a bulkhead, keeping the connections dry and reliable. The BG-One has two integrated sensors to ensure a reliable and accurate detection.

### How It Works

With precise oil and fuel detection accuracy down to 1 mm (0.04 in), the BG-One minimizes the boat owners' liability for costly cleanup and possible fines; all while extending the life and reliability of the bilge pump through selective pumping. When the sensor is configured in its factory default mode, Mode A (Marina), the pump will turn ON when water is detected and turn OFF when oil or fuel is detected. The pump will turn back ON when only water is detected. In Mode B (Marine Sanctuary) the pump will turn ON when water is detected and turn OFF when oil or fuel is detected. The pump will remain OFF until the alarm and bilge is cleared (requires power cycling of device). In Standard Mode (High Seas) the pump will turn ON when any liquid is detected and turn OFF when there is no liquid detected. Set low, medium, or high oil detection sensitivity via the BGI Config App. Set the pump run time after water and oil detection via the BGI Config App.

# FEATURES

## Oil and Fuel Detection

Down to 1 mm (0.04 in)

## Reliability

Two integrated sensors – solid-state with no moving parts or mechanical float switches that can easily be damaged

## Smart Bilge Pump Switch

Built-in smart bilge pump switch for up to 20 amp bilge pumps – Mode A (Marina Mode) and Mode B (Marine Sanctuary) automatically turns off the bilge pump when oil or fuel is detected

## Integrated Bluetooth Connectivity

Connects to the BGI Config App available on iOS and Android devices

## Alarm Output

12 or 24 Vdc, 1 amp max

## Max Current

20 amps





## Operating Voltage

12 or 24 Vdc

# WIRES

## Five Wire System

Heavy-duty 14 gauge marine grade wires, 6 ft long

-  (Orange) Pump Auto Control
-  (Brown) Pump Power
-  (Black) Supply Negative / GND
-  (Yellow) Oil Detect Alarm
-  (Red) Pump Manual Control

# CONFIGURATION

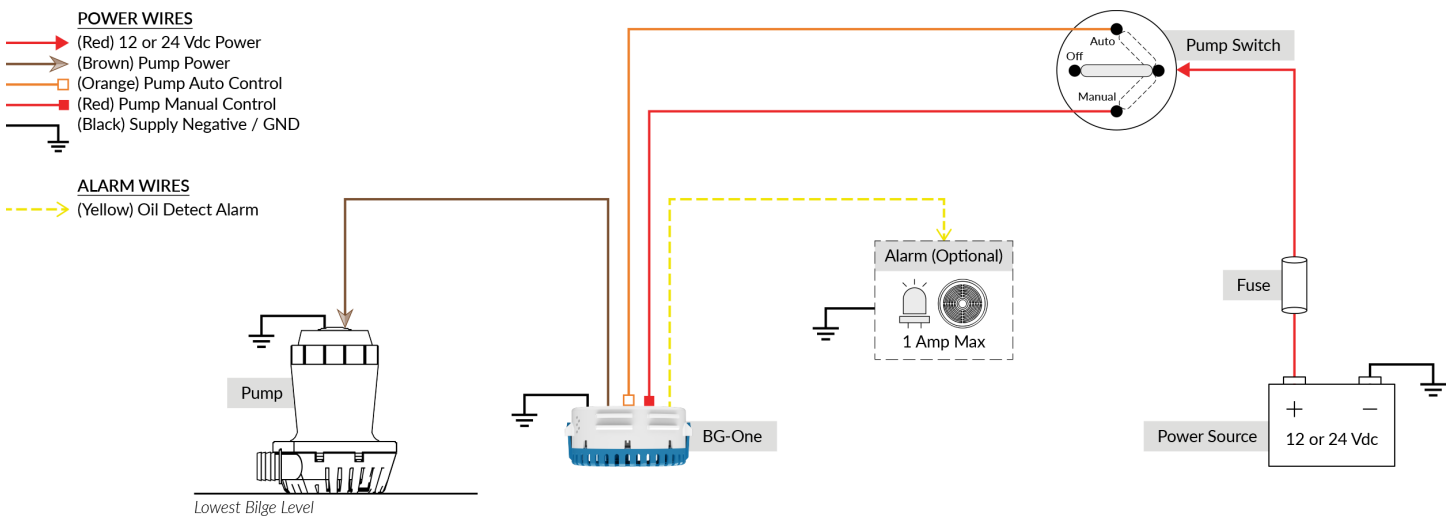

## IP-68 Rated Durability

Rugged, non-corrosive ABS plastic housing and mounting bracket

## Operating Temperature Range

### Operational with Full Functionality

32°F – 158°F / 0°C – 70°C

### Operational

-22°F – 185°F / -30°C – 85°C

## Compact Size

Without Mounting Bracket (D x H) – 4.6 in x 2.0 in

With Mounting Bracket (L x W x H) – 5.9 in x 4.6 in x 2.0 in

## Detachable Mounting Bracket

## CE & ISO 8846 Marine Ignition Protection Certified

Tested to ABYC-1500 Standards

# SMART SWITCH MODES OF OPERATION

## Configurable through the BGI Config App

### Mode A (Marina)

- Turns pump ON when water is detected
- Turns pump OFF when oil or fuel is detected
- Turns pump back ON when only water is detected

### Mode B (Marine Sanctuary)

- Turns pump ON when water is detected
- Turns pump OFF when oil or fuel is detected
- Stays OFF until alarm and bilge is cleared (Requires power cycling of device)

### Standard Mode (High Seas)

Bilge pump switch only (Will turn ON or OFF for any liquid)